



DESIGNED TO MOVE [YOU]

JWM6A

MOBILE AUDIO SYSTEM

Installation and Operation Manual

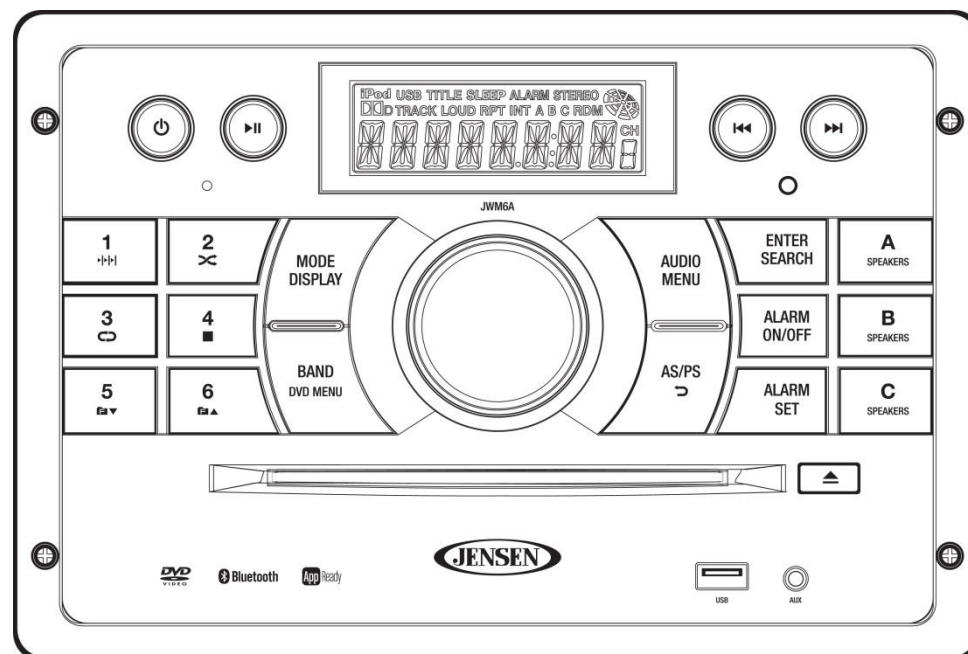



DESIGNED TO MOVE [you]

CONTENTS

Introduction.....	1
Disc Notes.....	2
Installation.....	3
Wiring.....	4
Basic Operation.....	5
Tuner Operation.....	28
Disc Operation.....	39
CD Operation.....	39
MP3/USB Operation.....	6-12
iPod® Operation.....	8-14
Bluetooth Operation.....	9-15
App Operation.....	11-17
Remote Control Operation.....	12-18
DVD Setup MenuU.....	14-20
Care and Maintenance.....	16-22
Troubleshooting.....	16-22
Specifications.....	17-23

Copyrights and Trademarks

All related marks and logos are trademarks of Sirius XM Radio Inc. All rights reserved.

“Made for iPod” and “Made for iPhone” mean that an electronic accessory has been designed to connect specifically to iPod or iPhone respectively, and has been certified by the developer to meet Apple performance standards. Apple is not responsible for the operation of this device or its compliance with safety and regulatory standards. Please note that the use of this accessory with iPod or iPhone may affect wireless performance.

© Copyright 2015 ASA Electronics, LLC PATENT PENDING



DESIGNED TO MOVE [you]

INTRODUCTION

Thank You!

Thank you for choosing a Jensen product. We hope you will find the instructions in this owner's manual clear and easy to follow. If you take a few minutes to look through it, you'll learn how to use all the features of your new Jensen receiver for maximum enjoyment.

Features

Features of Jensen JWM6A mobile audio system include:

- Digital AM/FM Tuner/30 Preset stations (12 AM/18 FM)
- Bluetooth Ready with A2DP/AVRCP Streaming Audio
- APP Ready
- Pre-set Equalizer - 5 settings (User > Flat > Pop > Classical > Rock)
- Electronic Bass, Treble, Balance and Fader Controls
- Skip Protected Disc Mechanism
- DVD/CD-R/RW and MP3 Compatible
- HDMI Video Output with JCOM link
- Low Battery Alarm
- Time/Alarm Clock
- White LED Backlight LCD
- 1/8" Front Auxiliary Audio Input
- Rear Audio RCA Inputs/Outputs
- USB Playback of MP3/WMA Files
- Made for iPod/iPhone (USB Input)
- 3 Zone / 8 Speaker Output
- Wireless Remote Control Included
- HDMI ARC function

Precautions

- **Use the Proper Power Supply.**
This product is designed to operate with a 12 volt DC, negative ground battery system (the standard system in a North American vehicle).
- **Protect the Disc Mechanism.**
Avoid inserting any foreign objects into the slot of this player. Failure to observe this may cause malfunction due to the precise mechanism of this unit.
- **Use Authorized Service Centers.**
Do not attempt to disassemble or adjust this precision product; contact a professional for assistance.
- **Avoid Moisture.**

To reduce the risk of fire or electric shock, do not expose this equipment to rain or moisture.

- **Avoid Cleaning Products.**
The front of this unit should only be cleaned with a slightly damp cloth. Do not use cleansers.
- **Use Recommended Accessories.**
TO REDUCE THE RISK OF FIRE OR ELECTRIC SHOCK AND ANNOYING INTERFERENCE, USE ONLY THE RECOMMENDED ACCESSORIES.

CAUTION: This mobile DVD player is a Class I laser product that uses a visible/invisible laser beam which could cause hazardous radiation exposure if improperly directed. Be sure to operate the mobile DVD player as instructed. Use of controls or adjustments or performance of procedures other than those specified herein may result in hazardous radiation exposure. Do not open covers and do not attempt to repair the unit yourself. Refer servicing to qualified personnel.

Packing List

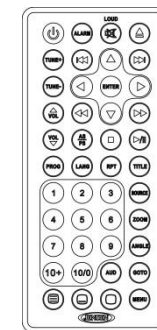
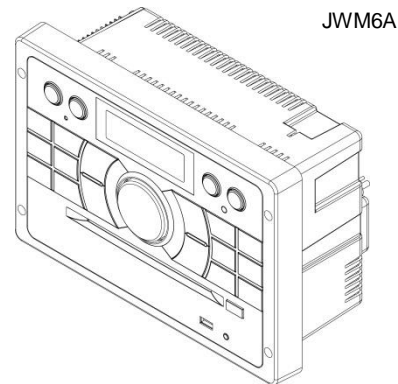

REMOTE CONTROL

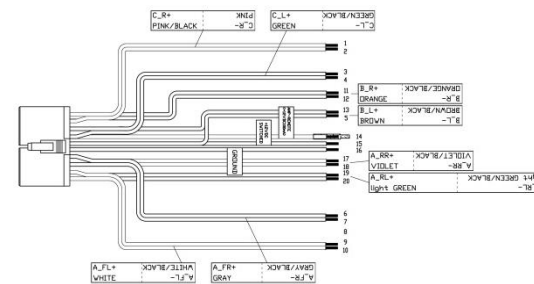

20-PIN SPEAKER WIRE

DISC NOTES

Depending on the recording status, conditions of the disc, and the equipment used for recording, some CD-Rs/CD-RWs may not play on this unit. For more reliable playback, please adhere to the following recommendations:

- Use CD-RWs with speed 1x to 4x and write with speed 1x to 2x.
- Use CD-Rs with speed 1x to 8x and write with speed 1x to 2x.
- Do not play a CD-RW which has been written more than 5 times.

Compatible Disc Types

Table 1: General Disc Information

Symbol	12cm Disc Properties	Max Play time
	Single side single layer (DVD-5)	(MPEG 2 Method) 133 minutes
	Single side double layer (DVD-9)	242 minutes
	Double side single layer (DVD-10)	266 minutes
	Double side double layer (DVD-18)	484 minutes
	Single side single layer (VCD)	MPEG 1 Method 74 minutes
	Single side single layer	74 minutes

NOTE: CD-R and CD-RW discs will not play unless the recording session is closed and the CD is finalized.

Disc Maintenance

- A dirty or defective disc may cause sound dropouts while playing. Before playing, wipe the disc using a clean cloth, working from the center hole towards the outside edge. Never use benzene, thinners, cleaning fluids, anti-static liquids or any other solvent.

- Be sure to use only round CDs for this unit and do not use any special shape CDs. Use of special shape CDs may cause the unit to malfunction.
- Do not stick paper or tape on the disc. Do not use CDs with labels or stickers attached or that have sticky residue from removed stickers.
- Do not expose discs to direct sunlight or heat sources such as hot air-ducts, or leave them in a vehicle parked in direct sunlight where there can be a considerable rise in temperature inside the vehicle.

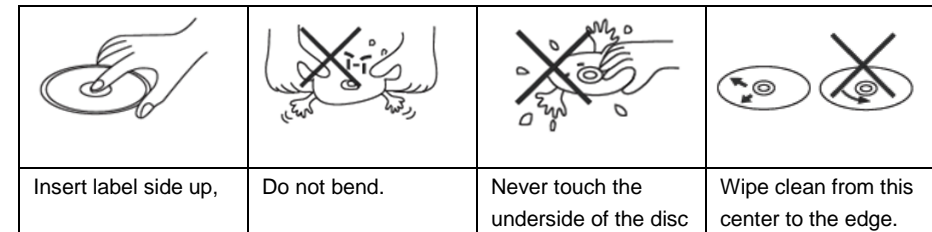

NOTE: A disc may become scratched (although not enough to make it unusable) depending on how you handle it and other conditions in the usage environment. These scratches are not an indication of a problem with the player.



INSTALLATION

It's a good idea to read all of the instructions before beginning the installation. We recommend having your Jensen JWM6A installed by a reputable RV dealership

Tools and Supplies

You will need these tools and supplies to install your JWM6A:

- Phillips screwdriver
- Wire cutters and strippers
- Tools to remove existing radio (screwdriver, socket wrench set or other tools)
- Electrical tape
- Crimping tool
- Volt meter/test light
- Crimp connections
- 16 gauge wire for power connections
- 16 – 18 gauge speaker wire
- Four M3x20mm (3/32 x 0.75") screws

Disconnecting the Battery

To prevent a short circuit, be sure to turn off the ignition and remove the negative (-) battery cable prior to installation.

NOTE: If the JWM6A is to be installed in a vehicle equipped with an on-board drive or navigation computer, do not disconnect the battery cable. If the cable is disconnected, the computer memory may be lost. Under these conditions, use extra caution during installation to avoid causing a short circuit.

Selecting the Mounting Location

Select a mounting location, taking care to avoid the following:

- Places exposed to heat-radiating appliances such as electric heaters
- Adjacent to other equipment that radiates heat
- Poorly-ventilated or dusty places
- Moist or humid locations

Mounting the Radio

- Use the mounting hole diagram to measure and cut a mounting hole
- Route power, speakers, AV, and antenna cables through the hole and connect
- Check and ensure correct operation
- Mount the unit using four M3x20mm (3/32 x 0.75") screws
- Attach Trim ring

NOTE: Before cutting the mounting hole, make sure the area behind the mounting location is clear of wires, fuel and vacuum or brake lines.

WIRING

The wiring diagram depicts all the wiring connections required for proper operation of the unit.

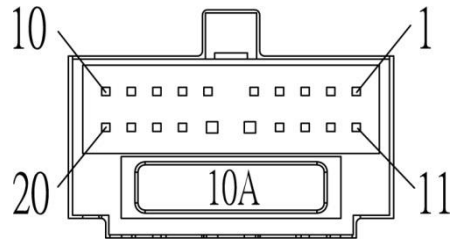

DETAIL A
SHOWN FROM PIN VIEW

PIN NO.	WIRE COLOR	DESCRIPTION
1	PINK/BLACK	RIGHT (C) SPEAKER (-)
2	PINK	RIGHT (C) SPEAKER (+)
3	GREEN	LEFT (C) SPEAKER (+)
4	GREEN/BLACK	LEFT (C) SPEAKER (-)
5	BROWN/BLACK	LEFT (B) SPEAKER (-)
6	GRAY	FRONT RIGHT (A) SPEAKER (+)
7	GRAY/BLACK	FRONT RIGHT (A) SPEAKER (-)
8	N/A	N/A
9	WHITE/BLACK	FRONT LEFT (A) SPEAKER (-)
10	WHITE	FRONT LEFT (A) SPEAKER (+)
11	ORANGE	RIGHT (B) SPEAKER (+)
12	ORANGE/BLACK	RIGHT (B) SPEAKER (-)
13	BROWN	LEFT (B) SPEAKER (+)
14	BLUE	AMP REMOTE (+12VDC 100mA)
15	RED	+12VDC SWITCHED
16	BLACK	GROUND
17	VIOLET	RIGHT REAR (A) SPEAKER (+)
18	VIOLET/BLACK	RIGHT REAR (A) SPEAKER (-)
19	LIGHT GREEN/BLACK	LEFT REAR (A) SPEAKER (-)
20	LIGHT GREEN	LEFT REAR (A) SPEAKER (+)

WARNING: Wiring harness comes with stripped and tinned leads to aid in the installation process. Any unused speaker wires *must* have their exposed ends cut off or insulated individually.

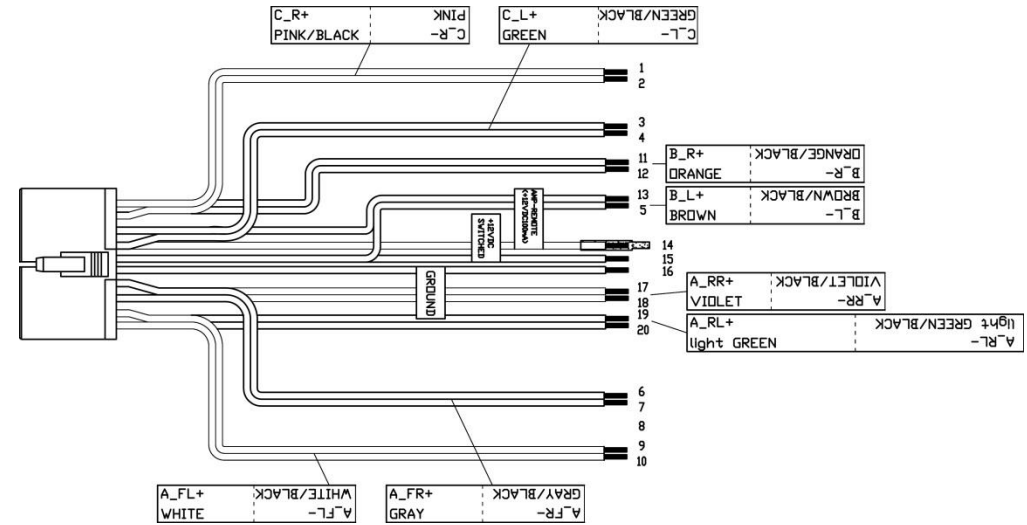

CONNECTIONS

The diagram below depicts all the available audio/video connections available to use with your system.

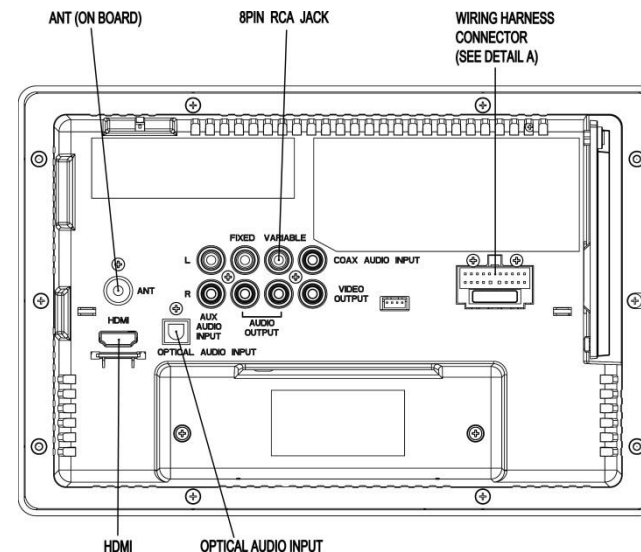

BASIC OPERATION

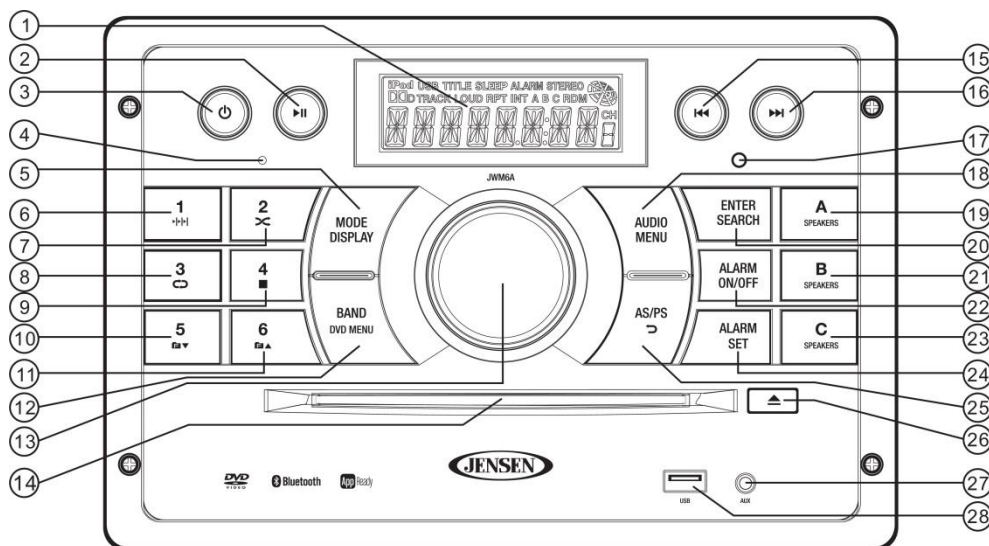

Power

Press the power button (3) to turn the unit on. The unit will resume at the last mode (Tuner, Aux, etc.).

Volume Control

To increase the volume, rotate the volume encoder knob (13) clockwise. To decrease the volume, rotate the volume encoder knob (13) counter-clockwise. The maximum volume setting is "40". While adjusting the volume, the LCD displays numerical representation of the level.

Pause / Mute

During RADIO / COAX / OPTIC mode, press the ►|| button (2) to mute the audio output. Press again to restore the previous volume level.

During USB / iPod / DVD / BT mode, press the ►|| button to pause playback. Press again to resume playback.

Mode / Display

1. Press **MODE/DISPLAY** button (5) to cycle through the available modes and choose desired mode.
2. Available modes include RADIO (AM/FM), BT MODE, AUX1 IN, AUX2 IN, COAXIAL, OPTICAL, USB, iPod and DISC (CD/VCD/DVD).HDMI ARC

Audio Menu

1. Press the **AUDIO MENU** button (18) to access the audio menu.
2. You can navigate through the audio menu items by pressing the >>| or |<< buttons (16, 15) or **AUDIO MENU** button repeatedly.
3. Once the desired menu item appears on the display, adjust that option by rotating the volume encoder knob clockwise or counter-clockwise within 5 seconds
4. Press the **ENTER SEARCH** button (20) to confirm your selection and exit audio menu. The unit will automatically exit the audio menu after 5 seconds of inactivity.

The following audio menu items can be adjusted:

- **BASS:** Adjust the Bass level range from "-7" to "+7".
- **TREBLE:** Adjust the Treble level range from "-7" to "+7".
- **BALANCE:** Adjust the Balance between the left and right speakers from "LEFT 7" (full left) to "RIGHT 7" (full right). "0" indicated an equal balance between the left and right speakers.
- **FADE:** Adjust the speaker fade between the rear and front speakers from "REAR 7" (full rear) to "FRONT 7" (full front). "0" indicated an equal balance between the rear and front speakers.
- **LOUDNESS:** Toggle the loudness on/off. When listening to music at low volumes, this feature will boost the bass/treble ranges to compensate for the characteristics of human hearing.
- **EQUALIZATION:** Choose one of the following pre-defined bass and treble curves: POP > CLASSICAL > ROCK > FLAT.

System Menu

1. Press and hold the **AUDIO MENU** button (18) for 2 seconds to enter the system menu.
2. Press the |<< or >>| buttons (15, 16) or **AUDIO MENU** button repeatedly to navigate the system menu.
3. Once the desired menu item appears on the display, adjust that option by rotating the volume encoder knob clockwise or counter-clockwise within 10 seconds.
4. Press the **ENTER SEARCH** button to confirm your selection and exit audio menu. The unit will automatically exit the audio menu after 10 seconds of inactivity.

The following items can be adjusted:

- **Beep On/Off:** Turn the audible beep On/Off (heard when functions/buttons are selected).
Note: Beep tone off will not affect the audible tone of the alarm clock.
 - **BRI(off,1,2,3,4):** Adjust the brightness of the LCD backlight from the following levels: 4,3,2,1 or off.
- **Region (USA/Europe):** Set frequency spacing for various regions.
- **LO BAT ALERT (On/Off):** Monitor voltage on ACC line and send alert when voltage is low.
- **Bluetooth Device (Lock/Unlock, Disconnect/Connect, Delete):** View, lock and delete from a list of previously paired mobile phone device models.
- **Bluetooth Pair:** Choose "ENTER" to automatically pair a device.

- Bluetooth (On/Off): Choose “Bluetooth On” or “Bluetooth Off”.
- PRESET VOL: (1/40-40/40): Select an automatic turn-on volume.
- RESET <ENTER>: Press the **ENTERSEARCH** button to return the JWM6A to factory default set up values.

Auxiliary Input Function

When a portable audio device is connected to the unit, press the **MODE DISPLAY** button (5) repeatedly until AUX1 IN / AUX2 IN mode is selectable. To connect a portable audio device, insert a standard 3.5mm (audio line output or headphone output from your portable CD / MP3 / iPod or other media player) into the **AUX** connector (AUX FRONT) (27) on the front of the unit or the **AUX-IN** RCA jack (AUX AUDIO INPUT) on the rear of the unit.

Auxiliary Input Connector

For front panel audio input, an external audio source can be connected to the front panel audio input with a 3.5mm audio cable adapter. Connect the device to the **AUX** connector (27) on the front panel.

In addition to front panel auxiliary input source, the unit can also be connected to the RCA audio input through the **AUX AUDIO INPUT** jack on the rear of the unit.

Coaxial

When a portable audio device is connected to the unit, press the **MODE DISPLAY** button repeatedly until Coaxial mode is selectable. To connect a portable audio device, connect the coaxial cable output from your portable CD / MP3 / iPod or other media player into the Coaxial Jack on the rear of the unit.

Optical

When a portable audio device is connected to the unit, press the **MODE DISPLAY** button repeatedly until Optical mode is selectable. To connect a portable audio device, connect the optical cable output from your portable CD / MP3 / iPod or other media player into the Optical Jack on the left of the unit.

USB Interface Connector

You can connect a USB device directly to USB interface (28) on the front of the JWM6A for playback of compatible files. Playback begins automatically. Press the **MODE DISPLAY** button repeatedly until USB mode is selectable. Refer to “MP3/USB Operation” on page 12 for additional operating instructions.

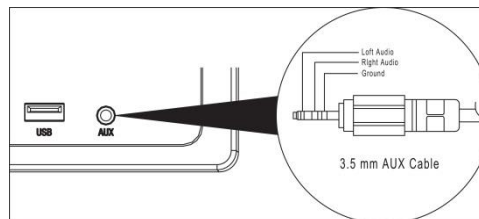

Liquid Crystal Display (LCD)

The current activated functions and time are shown on the LCD panel (1).

NOTE: LCD panels may take longer to respond when subjected to cold temperatures for an extended period of time. In addition, the visibility of the numbers on the LCD may decrease slightly. The LCD display will return to normal when the temperature increases to a moderate range.

Clock Setup

Press and hold the **MODE DISPLAY** button (5) for 2 seconds to enter to clock mode. Press and hold **ALARM ON/OFF** button (22) for 2 seconds and the clock displayed on the LCD will be flashing. Then, press the |<< button (15) to adjust the hour or press the >>| button (16) to adjust the minute. Continue adjusting the hour to move from AM to PM. Press the **ENTER SEARCH** button (20) to save the new time and exit the clock setting menu.

If the new time is not confirmed by pressing the **ENTER SEARCH** button, the unit will automatically exit the clock setting menu after 10 seconds of inactivity and the new time will be set.

Setting the Alarm

To set the alarm, press and hold the **ALARM SET** button (24) for 2 seconds and the clock digits will be flashing. Press the |<< button (15) to adjust the hour or press the >>| button (16) to adjust the minute of the alarm time. Continue adjusting the hour to move from AM to PM. Press the **ENTER SEARCH** button to save the new alarm time and exit the alarm setting menu. Press the **ALARM ON/OFF** button to turn the alarm on or off. The “ALARM” on the LCD display will illuminate correspondingly.

If the new alarm time is not confirmed by pressing the **ENTER SEARCH** button, the unit will automatically exit the alarm setting menu after 10 seconds of inactivity and the new alarm time will be set.

Sleep Time

The Sleep Timer will automatically turn off the JWM6A in the designated number of minutes.

To set the Sleep Time, press the **ALARM SET** button (24) and the sleep time will be displayed with the number representing the minutes (SLEEP 15). Press **ALARM SET** button repeatedly to change the sleep time from OFF, 15, 30, 45 or 60 minutes. The “ON” or “OFF” under the “SLEEP” at the right bottom corner will illuminate correspondingly.

Press the **AS/PS** button (25) to exit the sleep timer setting menu, or the unit will automatically exit the sleep timer setting menu after 10 seconds of inactivity.





Remote Sensor

Infrared receiver (17) is located on the front panel to receive infrared signal emitted by the remote control.

Speaker Output

The three speaker output buttons (**A SPEAKERS** (19), **B SPEAKERS** (21) and **C SPEAKERS** (23)) control speaker output from the radio. Press any of the three buttons to turn the corresponding speaker sets on or off. SPK A, SPK B or SPK C will appear on the display.

Reset

The reset button should be activated for the following reasons:

- Initial installation of the unit when all wiring is completed
- Function buttons do not operate
- Error symbol on the display

Use a ball point pen or thin metal object to press the reset button (4).

HDMI ARC

- Connect HDMI cable to JENSEN TV with ARC function and JWM6A head unit. If set up & operation is correct, the TV audio will come out from the speaker of head unit after changed the mode to HDMI ARC mode.
- ARC function Operation behavior as following table.

No	Device status		User operation	Operation results		Remark
	Head unit	TV		Head unit	TV	
1	Power On (HDMI ARC)	Power On	Power OFF TV	Power OFF	Power OFF	
2	Power OFF	Power OFF	Power ON TV	Power OFF	Power ON	
3	Power off (Last mode is HDMI ARC before power off)	Power off	Power ON Head unit	Power ON (HDMI ARC mode)	Power ON (last mode before power off)	
4	Power off (Last mode is HDMI ARC before power off)	TV,AV,USB,HDMI (non-HDMI ARC)	Power ON Head unit	Audio out	No audio out	TV audio out or not will depend on if TV can play the device automatically. If TV can't play the USB automatically, it needs to switch to USB mode for playing after mode switch.
5	Power On (HDMI ARC)	TV,AV,USB,HDMI (non-HDMI ARC)	Power OFF Head unit	No audio out	Audio out	
6	DISC Mode	Display Disc content	Switch TV to another mode (such as TV, AV, USB, non-HDMI ARC mode).	Switch to HDMI ARC Mode And Audio out from Head unit in HDMI ARC mode	No audio out	
7	HDMI ARC Mode	TV,AV,USB,HDMI (non-HDMI ARC)	Switch Head unit to another mode (Such as FM, Bluetooth, DVD or AUX).	No audio out(No HDMI ARC Audio out)	Audio out	TV Speaker : ON
8	HDMI ARC Mode	TV,AV,USB,HDMI (non-HDMI ARC)	TV Audio Receiver OFF	No audio out	Audio out	TV Speaker : ON
			TV Audio Receiver ON	Audio out	No audio out	TV Speaker : ON
9	HDMI ARC Mode	TV,AV,USB,HDMI (non-HDMI ARC)	TV CEC Mode OFF	No audio out	Audio out	TV Speaker : ON
			TV CEC Mode ON Audio Receiver ON	Audio out	No audio out	TV Speaker : ON

TUNER OPERATION

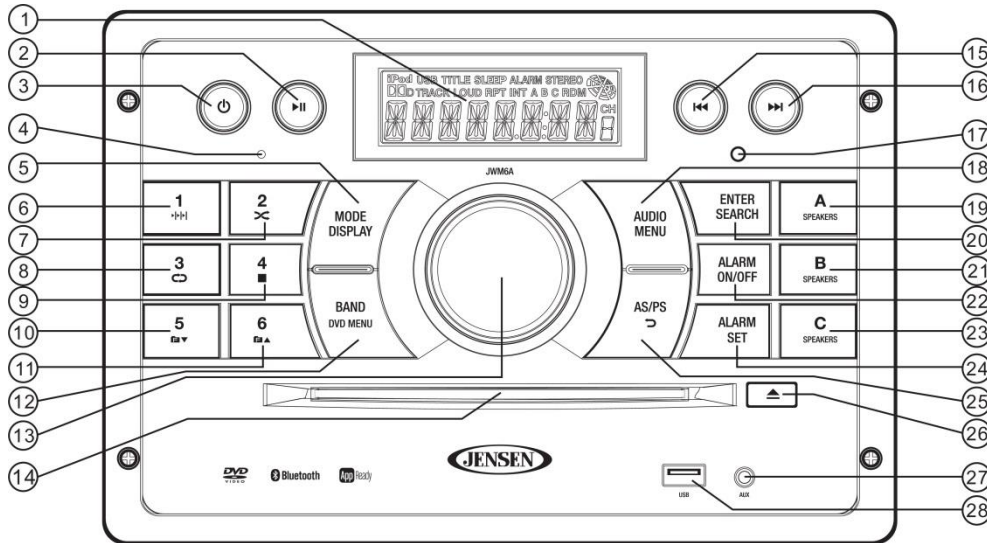

Select a Band

1. Press **MODE DISPLAY** button (5) repeatedly to select the radio mode.
2. Press **BAND DVD MENU** button (12) to select the band (AM1, AM2, FM1, FM2 and FM3).

Manual Tuning

Press the >>| or |<< buttons (16, 15) to seek stations up/down step by step.

Auto Seek Tuning

Press and hold the >>| or |<< buttons (16, 15) to automatically seek the next or previous strong station.

Preset Stations

Six numbered preset buttons store and recall stations for each AM and FM band.

Store a Station

Select a band (if needed), then select a station. Press and hold a 1-6 preset button for two seconds. The present number will

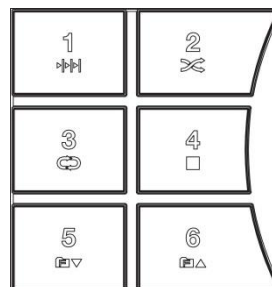

appear on the display.

Recall a Station

Select a band (if needed). Press a 1-6 preset button to select the corresponding stored station.

Automatically Store / Preset Scan (AS/PS)

Automatically Store

Select an AM or FM band. Press and hold the **AS/PS** button (25) for more than 3 seconds and the unit will automatically scan for and store 12 or 18 strongest stations for AM or FM respectively. To stop this function before the automatic storing is complete, press **AS/PS** again.

Preset Scan

Select a band. Press **AS/PS** button to scan stations stored in the current band. The unit will pause for 10 seconds at each preset station. Press **AS/PS** again to stop scanning when the desired station is reached.

DISC OPERATION

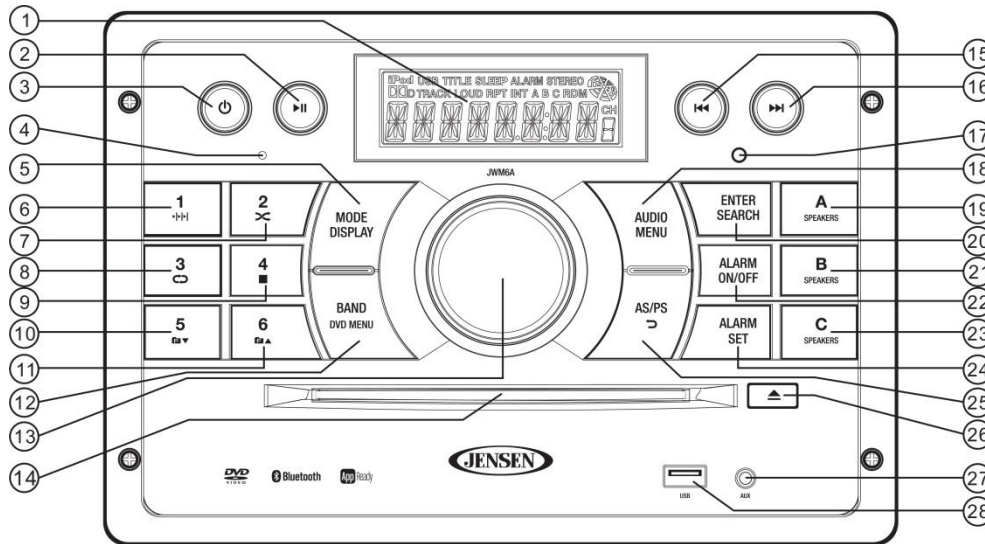

CD OPERATION

Inserting a CD

Insert a CD label-side up into the disc slot (14) and the disc will begin to play automatically.

Ejecting a CD

Press the eject button (26) to stop CD play and eject the CD.

Pausing Playback

Press the ►|| button (2) to suspend or resume disc play.

Stop Playback

Press the 4 ■ button (9) to suspend disc playback, "PRE STOP" will appear on the display. Press the ►|| button to resume disc playback from the last position. Press 4 ■ button twice, "STOP" will appear on the display.

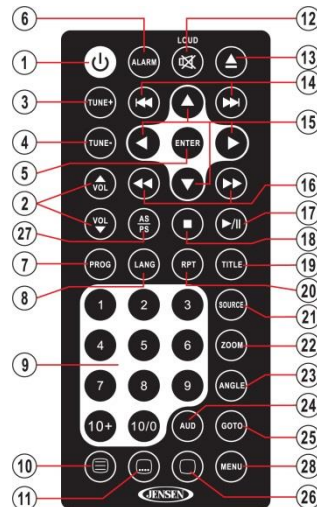

Track Select

Press the >>| button (16) or |<< button (15) to advance to the previous or next track on the CD. The selected track number will appear on the display. Press the ►|| button to start the playback of the selected track.

Fast Forward/Reverse

Press and hold the >>| button (16) or |<< buttons (15) or press the >> or << buttons on the remote control (16) once for FORWARD X 2. Press and hold additional times for FORWARD X 4, X 8, X 20 or PLAY. Press the ►|| button on the control panel or remote control (17) to end fast forward or reverse and resume normal playback

Intro Scan (INT)

Press the 10| button (6) during disc play to play the first 10 seconds of each track on the current disc. Press 10| again to end the scan and play the selected track.

Repeat (RPT)

Press the 3 CD button (8) or RPT buttons on the remote control (20) to access the repeat function. Press again to continuously repeat the selected track (RPT ONE). Press the third time to repeat all tracks (RPT ALL). Press one more time to stop the repeat function (RPT OFF).

Random Shuffle (RDM)

Press the 2 X button (7) to play all tracks on a CD in random, shuffled order (RDM ON). Press 2 X again to stop random play (RDM OFF).

Programmed Playback

1. Press the **PROG** button (7) on the remote control to access the programmed playback screen.
2. Use the ◀▶ or ▲▼ cursor buttons (15) on the remote control to access the fields on the "PROG" screen.
3. Use the number buttons on the remote control to enter a track number in each field.
4. Press the ►|| button (17) on the remote control or highlight "PLAY" on screen and then press the **ENTER** button (5) to begin playback in the numbered order indicated. To delete the list, highlight "CLEAR" and then press **ENTER**. Press **PROG** to exit the programmed playback screen.

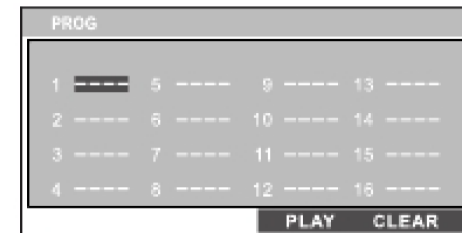

GOTO Direct Track/Chapter Access

Use the GOTO function to access a track (chapter) directly.

1. Press the **GOTO** button (25) on the remote control. The On Screen Display information will appear with the track number highlighted.
2. Use the number keys on the remote control to enter the 3-digit track number directly (i.e. for track 10, enter "010").
3. Press the **ENTER** button (5) to confirm and begin playback.

CD Playback Information

The following information is displayed at the top of the screen during CD playback:



TRK #### – "1/18" indicates the first of 18 tracks on the CD is currently playing.

– "X" indicates repeat play is OFF, "1" indicates repeat track, and "A" indicates repeat disc.

Press the button on the remote control (26) repeatedly to view the following information for elapsed/remaining playing time:

00:02:18 – total elapsed playing time of current track;

C – 00 :34 :37 – remaining playing time of current track;

T 00:02:18 – total elapsed playing time for current disc;

T – 00 :34 :37 – remaining playing time for current disc.

DVD/VCD OPERATION

Inserting a Disc

Insert a disc label-side up into the disc slot (14) and the disc will begin to play.

Ejecting a DVD

Press the eject button (26) to stop DVD play and eject the DVD.

Pausing Playback

Press the button (2) to suspend or resume disc play.

Stop Playback

Press the **4** button (9) to suspend disc play, and "PRE STOP" will appear in the display.

Press the button (2) to resume disc play from the last position. Press **4** button (9) twice, "STOP" will appear on the display.

Track Select

Press the or button (16, 15) to advance to the next or previous track on the disc. The selected track number will appear on the display

MENU Select

While in menu mode, press the **BAND DVD MENU** button (12) to select a menu option.

Language Selection

While playing a DVD, press the **6 FOLDER UP** button (11) to change the DVD audio language

Fast Forward/Reverse

Press and hold the button (16) or buttons (15) or press the or buttons on the remote control (16) once for FORWARD X 2. Press and hold additional times for FORWARD X 4, X 8, X 20 or PLAY. Press the button on the control panel (2) or remote control (17) to end fast forward or reverse and resume normal playback

Repeat Chapter/Title

Press the **3** button (8) on the control panel or the **RPT** button (20) on the remote control multiple times during playback to select from the following repeat play options:

- VCD: RPT 1 (track), RPT ALL (disc), RPT OFF
- DVD: RPT Chapter, RPT Title, RPT All, RPT OFF

Programmed Playback

1. Press the **PROG** button (7) on the remote control to access the programmed playback screen.
2. Use the or cursor buttons (15) on the remote control to access the fields on the "PROG" screen.
3. Use the number buttons on the remote control to enter a track number in each field.
4. Press the button (17) on the remote control or highlight "PLAY" on screen and then press the **ENTER** button (5) to begin playback in the numbered order indicated. To delete the list, highlight "CLEAR" and then press **ENTER**. Press **PROG** to exit the programmed playback screen."

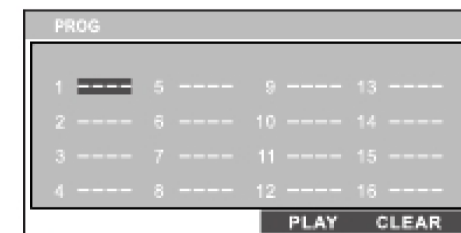

DVD Playback Features

The following remote control features, along with many others, are available during DVD playback (see "Remote Control Operation" on page 18 for complete functionality):

- LANG: Press to choose an alternate audio language, if available,

- SUBTITLE: Press to select an alternate subtitle language, if available,
- ANGLE: Press to select an alternate viewing angle, if available.
- ZOOM: Press to zoom the picture at ZOOM 2, ZOOM 3, ZOOM 4, ZOOM 1/2, ZOOM 1/3 or ZOOM 1/4, or select OFF to return to normal view.

NOTE: Feature availability is dependent upon DVD embedded information.

Playback Information

During DVD playback, press the button (26) on the remote control to display playback information on the screen, including the media playing and current playback time. Press the button (26) additional times to display additional information, as indicated below.

DVD Playback Information

The following information is displayed at the top of the screen during DVD playback:

DVD TT 5/8 CH 2/16  -00:33:34

 1/5 ENG  5.1 CH  1/4 ENG  OFF

TT 5/8 – “5 / 8” indicates the fifth of 8 titles on the DVD is currently playing.

CH 2/16 – “2 / 16” indicates that the second of 16 chapters on the DVD is currently playing.

Press repeatedly to view the following information for elapsed/remaining playing time:

 00:02:18 – total elapsed playing time of the current track;

C – 00:34:37 – remaining playing time of the current track;

T 00:02:18 – total elapsed playing time for disc;

T – 00:34:37 – remaining playing time for disc. .

 1/5 ENG – English is the selected audio language out of 5 possible choices;

 5.1 CH – The current language is recorded in 5.1 surround sound;

 1/4 ENG – English is the selected subtitle language out of 4 possible choices;

 OFF – There are no alternate angles recorded for this scene.

Remote Control Direct Track Entry

To select a track directly, use the number pad on the remote control (9). For single digit entries, press the corresponding number. For two digit entries, press the 10+ button followed by the last digit (i.e., for track 16, press 10+ and then 6).

GOTO Direct Track/Chapter Access

Use the GOTO function to access a track (chapter) directly.

1. Press the **GOTO** button (25) on the remote control. The On Screen Display information will appear with the track number highlighted.
2. Use the number keys on the remote control to enter the 3-digit track number directly (i.e. for track 10, enter “010”).
3. Press the **ENTER** button to confirm and begin playback.

MP3/USB OPERATION

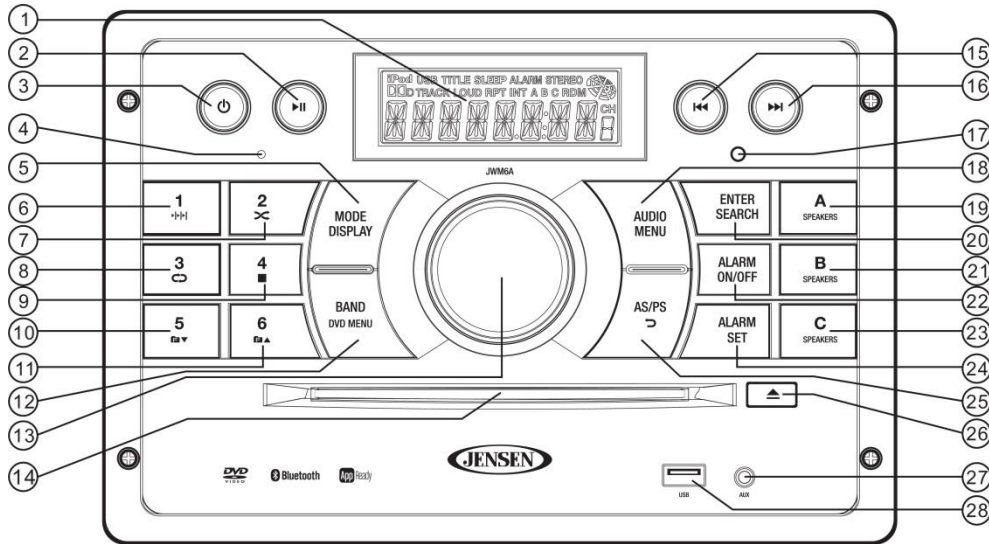

If the user connects a USB mass storage device, the radio automatically powers on, if necessary, and switches to digital file playback mode and selects that physical media. Changing modes or turning off the radio pauses playback. Playback will resume exactly where paused when returning to digital file playback mode.

Inserting a USB Device

The **USB connector** (28) is at the bottom right corner of the panel. Insert a USB device to automatically access USB mode and begin playback. The LCD will display "LOADING" and "USB" while files are initially loaded.

When USB is removed, it will automatically back to the previous mode before the USB is connected. During other playback mode, when USB is connected, press **MODE DISPLAY** button to enter USB playback mode directly.

NOTE: MP4 video format is not supported.

MP3 Specifications

Notes on MP3 Playback

- Any directory that does not include an MP3 file is

skipped

- Maximum number of folders: 512 (including skipped directories)
- Maximum number of folder levels: 12
- Maximum number of MP3 files: 999
- Maximum number of characters for MP3 file name and folder name: 32
- Maximum number of Characters of ID3 Tag:
 - ID3 Tag version 1.0: 32
 - ID3 Tag version 2.x: 32

MP3 Monitor Display

After loading an MP3 disc or USB device, the following screen will appear on your output monitor.

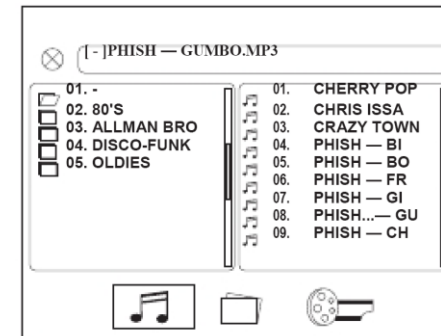

Select one of these icons to access the corresponding media on your disc or USB device.

If the media type is not present, the icon will not be selectable.



Play/Pause

Press the **▶||** button (2) to suspend or resume disc play

Track Select

Press the **>>|** or **|<<<** button (16, 15) or **|<<<** or **>>|** button (14) on the remote control to advance to the next or previous track in the current folder. The selected track number will appear on the display.

Folder Up/Down

Press and hold the **6** (11) to access a higher folder level (FOLDER UP).

Press and hold the **5** (10) to access a lower folder level (FOLDER DN).

Intro Scan (INT)

Press the **1|1|1|** button (21) during disc play to play the first 10 seconds of each track on the

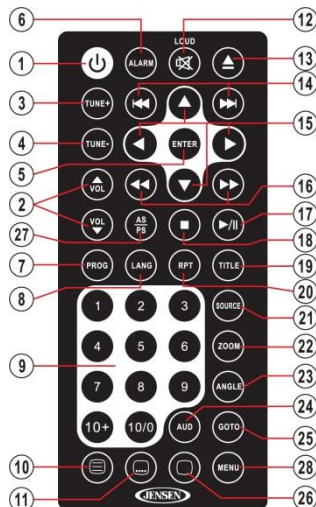



current disc. Press **1**  again to end the scan and play the selected track.

Repeat (RPT)

Press the **3**  button (8) on the control panel or the **RPT** button (20) on the remote control multiple times during playback to select from the following repeat play options: RPT 1 (track), RPT DIR (folder), RPT ALL (disc), OFF.

Random Shuffle (RDM)

Press the **2**  button (7) during song playback to play all files in random, shuffled order. Press **2**  again to stop random play.

Fast Forward/Reverse

Press and hold the **>>** or **<<** buttons or press the **>>** or **<<** buttons on the remote control (16) once for FORWARD X 2. Press and hold additional times for FORWARD X 4, X 8, X 20 or PLAY. Press the **▶||** button on the control panel (2) or remote control (17) to end fast forward or reverse and resume normal playback

Programmed Playback

1. Press the **PROG** button (7) on the remote control to access the programmed playback screen.
2. Use the **◀▶** or **▲▼** cursor buttons (15) on the remote control to access the fields on the "PROG" screen.
3. Use the number buttons on the remote control to enter a track number in each field.
4. Press the **▶||** button (17) on the remote control or highlight "PLAY" on screen and then press the **ENTER** button (5) to begin playback in the numbered order indicated. To delete the list, highlight "CLEAR" and then press **ENTER**. Press **PROG** to exit the programmed playback screen."

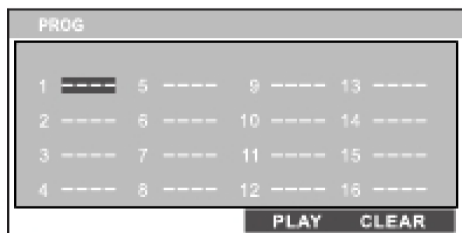

Remote Control Direct Track Entry

To select a file directly, use the number pad on the remote control (9). For single digit entries, press the corresponding number. For two digit entries, press the 10+ button followed by the last digit (i.e., for file 16, press 10+ and then 6).

GOTO Direct Track/Chapter Access

Use the GOTO function to access a track (chapter) directly.

1. Press the **GOTO** button (25) on the remote control. The On Screen Display information will appear with the track number highlighted.
2. Use the number keys on the remote control to enter the 3-digit track number directly (i.e. for track 10, enter "010").
3. Press the **ENTER** button (5) to confirm and begin playback.

iPod® OPERATION

This unit is equipped with an iPod® ready function that will allow you to control your iPod (if compatible) using the control panel buttons. The following models are supported:

- iPod Nano 5G, 6G, 7G
- iPod Classic
- iPod Touch 3G, 4G, 5G
- iPhone 4, 4S, 5, 5C, 5S

NOTE: Earlier model iPods are not supported because they do not implement the required control protocol. Also, the iPod shuffle is not supported because it does not utilize the 30-pin Apple iPod Connector. These unsupported iPod models may be connected to the radio using one of the Auxiliary Inputs.

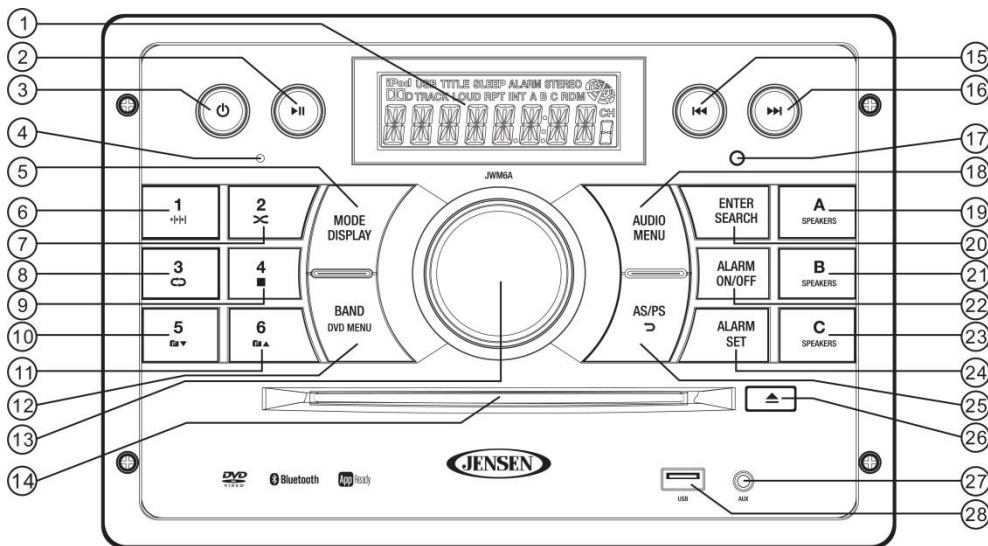

Accessing iPod Mode

Connect a supported iPod or iPhone to the **USB connector** (28). The word “iPod” illuminates in the upper left corner of the LCD whenever an iPod or iPhone is attached to the USB connector. Music playback begins automatically.

To enter iPod mode from any other source, press the **MODE DISPLAY** button (5) repeatedly to enter the iPod mode. Then “Loading” and “iPod” will be shown on the display.

If the user connects an iPod containing no songs, the radio will display a message stating “No

Songs” when it enters iPod mode. When iPod is disconnected, it will automatically back to the previous mode before the USB is connected. During other playback mode, when USB is connected, press **MODE DISPLAY** button to enter USB playback mode directly.

Turning the iPod On/Off

The iPod power turns on automatically when an iPod is connected to the USB connector, as long as the vehicle ignition is turned on. You can turn the iPod off by disconnecting it or by turning the ignition off. When the ignition is turned off, the iPod will pause and then enter sleep mode after 2 minutes. While the iPod is connected, the power cannot be turned on or off from the iPod itself.

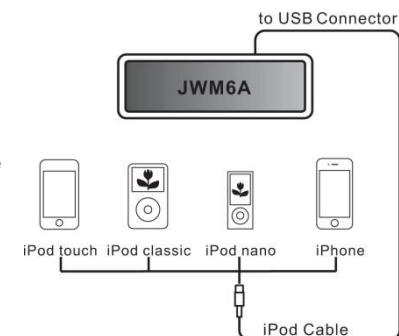

NOTE: The iPod will continuously recharge while in iPod playback mode.

Controlling Playback

Selecting Tracks

During playback, press the **>>|** button (16) to play the next track in the current category. During the first 2 seconds of the playback, press the **|<<** button (15) to play the previous track. After the first 2 seconds of the playback, press the **|<** button to play the current song from the start. Press and hold the **|<< | >>|** buttons to fast reverse/forward the song.

Pausing Playback

During playback, press the **▶||** button (2) to pause playback. “Pause” will appear on the LCD. Press **▶||** button again to resume playback.

Repeat Play

During playback, press the **3⏮** button (8) to repeat the current song. “RPT ONE” will appear on the LCD. Press **3⏮** again to repeat all songs in the current category. “RPT ALL” will appear on the LCD. Press **3⏮** the third time to stop repeat playback. “RPT OFF” will appear on the LCD.

Random Play

During playback, press the **2⌘** button (7) to play all songs in the current category in random order. Random play will begin once the current song has finished playing. “RDM ON” will appear on the LCD. Press **2⌘** again to stop random playback.

NOTE: If you press and hold the |<< or >>| button to change the current song to the previous/next song, you will exit fast reverse/forward mode.



DESIGNED TO MOVE [you]

Search Mode

Press and hold the **ENTER SEARCH** button (20) for more than 2 seconds to enter iPod search mode and choose from the following search criteria: Playlist, Artist, Album, Song, Genre, Composer, Audiobooks and Podcasts (consecutively).

When search mode is selected, press the **ENTER SEARCH** button to confirm selection. Use the **|<< / >>|** button (15/16) to navigate through various list selections. Press **ENTER SEARCH** to make your final selection.

BLUETOOTH OPERATION

The JWM6A includes built-in Bluetooth technology that allows you to connect this head unit to Bluetooth-enabled devices for streaming audio playback.

About Bluetooth Technology

Bluetooth wireless technology is a short-range wireless radio protocol. Operating in the 2.4 GHz range, it transmits audio and data at speeds up to 2.1 Mbit/s over a range of up to 10 meters.

Bluetooth Menu Options

NOTE: Please note that some Bluetooth menu options are only available while the unit is in Bluetooth Audio mode.

Press and hold the **AUDIO MENU** button (18) to enter menu adjustment mode. Repeatedly press the >>| or |<< buttons (16, 15) or **AUDIO MENU** button to access the "Bluetooth On/Off" menu function. Rotate the volume encoder knob (13) to select BLUETOOTH ON, then press the **ENTER SEARCH** button (20) to turn the Bluetooth function On or Off. The following menu options are available when the unit is in Bluetooth mode.

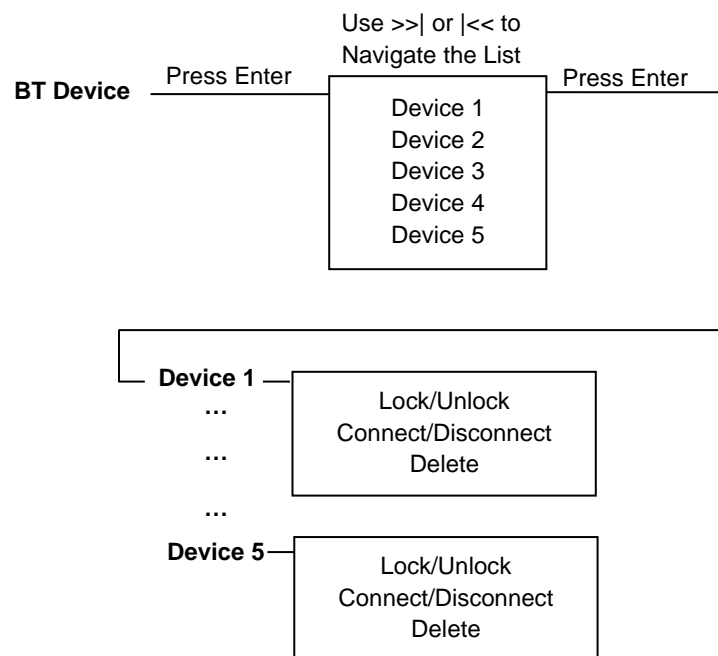

- **Bluetooth Pair <ENTER>:** Press and hold the **ENTER SEARCH** (20) button for about 4 seconds to start pairing with a Bluetooth enabled device.
- **Bluetooth Device:** Press the **ENTER SEARCH** button to view a list of previously paired mobile devices models. Press the >>| or |<< buttons to view devices from the list. You cannot delete a device that is actively connected. Press the **ENTER SEARCH** button to select the device. Press the >>| or |<< button to choose Lock/Unlock, Disconnect or Delete for this device.
 - **LOCK/UNLOCK:** The JWM6A can store up to 5 devices for Bluetooth connection. The devices are stored in FIFO (First In First Out) order. To prevent a device from being bumped from the list when more than 5 devices are used, you must lock the device. To Lock/Unlock a device, press the **ENTER SEARCH** to change Lock or Unlocked.
 - **DISCONNECT:** To disconnect a paired device, press the **ENTER SEARCH** button to temporarily remove the Bluetooth link. The link can be re-established through your phone menu by selecting the JWM6A for connection.
 - **DELETE:** To delete a device from the list, press the **ENTER SEARCH** button.

Pairing a Bluetooth Device

Before you begin, consult the owner's manual for the Bluetooth device you want to pair with the JWM6A.

1. Make sure the device is on and ready to receive a signal from the JWM6A. With the JWM6A in BT mode. Press and hold the **ENTER SEARCH** button for about 4 seconds. The unit is waiting to connect to a mobile phone device. With the Bluetooth function of the mobile device turned on, search for a Bluetooth device.
 2. When the Bluetooth device has completed its search, the mobile device will display the Bluetooth device name (JWM6A).
 3. Select BT PAUSE on the radio and enter the pairing password (0000), if requested.
- After connecting successfully, you will be able to listen to audio from your Bluetooth enabled device through the JWM6A.

Bluetooth Audio (A2DP)

The A2DP music is available for Bluetooth enabled phones when the phone is connected. To access Bluetooth mode and play songs stored in your phone. Repeatedly press the **MODE DISPLAY** button (5) to enter the Bluetooth mode.

While in Bluetooth mode, BT PAUSE will appear on the LCD.

Selecting Tracks

During playback, press the >>| or |<< button (16, 15) to play the previous or next track.

Pausing Playback

During playback, press the ►|| button (2) to pause the Bluetooth audio playback. "BT PAUSE" will appear on the LCD. Press ►|| button again to resume playback.

If you change to another mode, the mobile device audio will pause. Press the **MODE DISPLAY**



button (5) to return to Bluetooth mode and resume mobile device audio playback.

NOTE: If a Bluetooth device is disconnected due to the power being turned off or if the device is out of range, the unit will automatically search for the matching Bluetooth mobile device when the power is restored.

APP OPERATION

JENSEN® Specialty Controller is the ultimate wireless remote control for your JENSEN stereo system. Store away your old remotes and enjoy the convenience of all the primary functions of your JENSEN stereo right from your phone or tablet by transforming your mobile device into a functional stereo remote control!

Features

This app controls all of the primary functions of your stereo features including:

- Power on/off
- Volume and mute
- CD/DVD player
- AM/FM radio tuner: access station, recall, store presets, switch songs
- Bluetooth® streaming audio
- File structure visibility, track selection, track audible scan up and down via USB
- iPod/iPhone/iPad® control capabilities via USB
- Auxiliary audio input control –auxiliary analog 1 & 2, auxiliary digital coaxial, auxiliary digital optical
- Speaker selection A, B and/or C
- Audio menu controls- bass, treble, balance, fader, equalizer, volume and speaker selection settings
- Clock with sleep time and alarm
- Visual display feedback so you can see artist title and album on your mobile screen

Connecting and using jControl app

After downloading and installing jControl app on your apple device, pair your device to the JWM6A as stated above for Bluetooth pairing. Once your device is paired you can open the app and use as instructed with the jControl app manual found at <http://asaelectronics.com/manuals-guides>.

When jControl is installed on Android operating system, close the app before Bluetooth pairing, otherwise there may be errors on Bluetooth connection.

REMOTE CONTROL OPERATION

REF	DESCRIPTION	TUNER	WEATHERBAND	BLUETOOTH	CD/MP3/USB	DVD
1	Power	Turn radio on/standby mode.	Turn radio on/standby mode.	Turn radio on/standby mode.	Turn radio on/standby mode.	Turn radio on/standby mode.
2	VOL +/-	Adjust volume up/down. Press for Audio Control Setup menu.	Adjust volume up/down. Press for Audio Control Setup menu.	Adjust volume up/down. Press for Audio Control Setup menu.	Adjust volume up/down. Press for Audio Control Setup menu.	Adjust volume up/down. Press for Audio Control Setup menu.
3	TUNE +	Tune to higher station.	Tune to higher station.			
4	TUNE -	Tune to lower station.	Tune to lower station.			
5	ENTER				Confirm menu selection.	Confirm menu selection.
6	ALARM	Turn the alarm feature on/off.	Turn the alarm feature on/off.	Turn the alarm feature on/off.	Turn the alarm feature on/off.	Turn the alarm feature on/off.
7	PROG				Display Program Play Menu	Display Program Play Menu
8	LANG				Display MONO/L, MONO/R or STEREO.	Select alternate audio language, if available.
9	Numeric Keyboard	Use 1-6 to access preset stations.	Use 1-6 to access preset stations.		Enter track number to access track directly. For track Number > 10, use 10+ followed by second digit.	Enter track number to access track directly. For track Number > 10, use 10+ followed by second digit.
10	Setup				View SETUP menu.	View SETUP menu.
11	Subtitle					Choose subtitle language, if available.
12	Mute/LOUD	Silence Audio output. Press and hold to turn LOUDNESS feature on/off.	Silence Audio output. Press and hold to turn LOUDNESS feature on/off.	Silence Audio output. Press and hold to turn LOUDNESS feature on/off.	Silence Audio output. Press and hold to turn LOUDNESS feature on/off.	Silence Audio output. Press and hold to turn LOUDNESS feature on/off.
13	Eject	Eject Disc.	Eject Disc.	Eject Disc.	Eject Disc.	Eject Disc.
14	Previous/Next			Select next/previous track.	Select next/previous track.	Select next/previous chapter.
15	Directional Buttons				Move to desired menu item and then press ENTER to confirm.	Use with DVD menu to move to desired menu item and then press ENTER to confirm.
16	Fast Reverse/Forward				Fast Forward 2X, 4X, 8X, 20X. Fast Reverse 2X, 4X, 8X, 20X.	Fast Forward 2X, 4X, 8X, 20X. Fast Reverse 2X, 4X, 8X, 20X.
17	Play/Pause			Pause/resume playback.	Pause/resume playback.	Pause/resume playback.
18	Stop				Stop playback.	Stop playback.

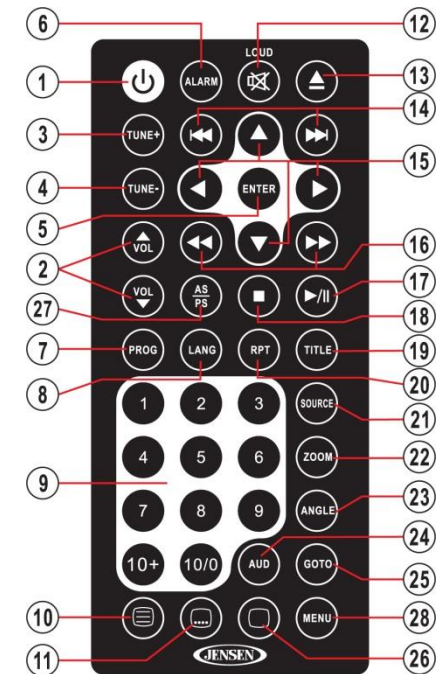



DESIGNED TO MOVE [you]

19	TITLE					Press to view title menu. Use directional arrows and play button to play selected title. May not be supported by all discs.
20	RPT				Repeat track.	Repeat chapter.
21	SOURCE	Select source for playback.	Select source for playback.	Select source for playback.	Select source for playback.	Select source for playback.
22	ZOOM					Zoom picture or press repeatedly to change magnification level.
23	ANGLE					Select alternate viewing angle, if available.
24	AUD	Access Audio Menu options.	Access Audio Menu options.	Access Audio Menu options.	Access Audio Menu options.	Access Audio Menu options.
25	GOTO				Select exact time, track or chapter for playback.	Select exact time, track or chapter for playback.
26	Display				Display current playback information on the screen.	Display current playback information on the screen.
27	AS/PS	Browse preset stations (10 sec. interval). Press and hold to scan/store stations.				
28	MENU	Access system MENU.	Access system MENU.	Access system MENU.	Access system MENU.	Press to access system MENU. <i>Press and hold</i> to access DVD MENU.

DVD SETUP MENU

Press the (setup) button (10) on the remote control to access the SETUP menu and adjust system settings for the following categories:

- System Setup
- Language Setup
- Audio Setup
- Video Setup
- Speaker Setup
- Digital Setup

While in the setup menus, use your directional arrows to select and change settings. The “up” and “down” arrows highlight the options, and the “right” and “left” arrows will change the setting for the highlighted option.

System Setup

The System Setup menu controls the following features:

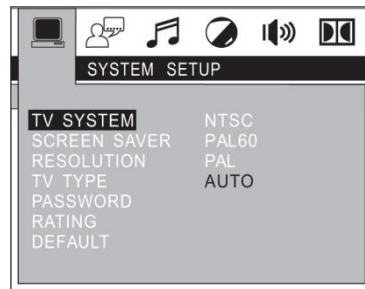

- **TV System:** This item is used to select a TV signal system to match your TV set. Select one of the following options: AUTO, NTSC or PAL.
- **Screen Saver:** Turn Screen Saver feature On/Off.
- **Resolution:** The fitness of detail that can be distinguished in an image. Select one of the following options: 480I/576L, 480I/576P, 720P, 1080I, 1080P.
- **TV Type:** Select one of the following picture formats: 4:3PS, 4:3 LB or 16:9. 4:3 is a letterbox selection, and 16:9 is wide screen.
- **Password:** This item allows the selection of a new four-digit code to use for security purposes.
- **Rating:** Select the parental control level for all DVD play. The security password is required to make changes to this feature.
- **Default:** Use this item to restore default settings at any time.

Language Setup

The Language Setup menu controls the following features:

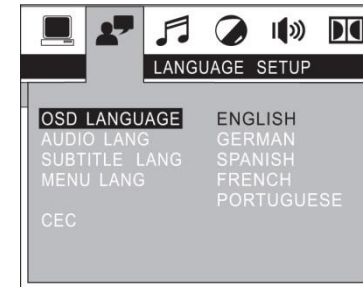

- **On-Screen Display (OSD) Language:** Set the OSD language to one of the following: English, German, Spanish, French, or Portuguese.
- **Audio Language:** Set the audio language to one of the following: Chinese, English, Japanese, French, Spanish, Portuguese, Latin or German.
- **Subtitle Language:** Set the subtitle language to one of the following: Chinese, English, Japanese, French, Spanish, Portuguese, German or OFF.
- **Menu Language:** Set the menu language to one of the following: Chinese, English, Japanese, French, Spanish, Portuguese, German or Latin.
- **CEC:** Default setting “ON” allows power ON/OFF and source selection controls between devices connected via HDMI. Turn “OFF” to disable this feature.

Audio Setup

The Audio Setup menu controls the following features:

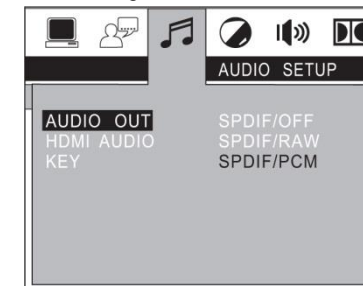

- **Audio Out:** This item defines the digital output format.
- **HDMI Audio:** Choose AUTO or PCM.
- **Key:** This item changes the audio output key.

Video Setup

The Video Setup menu controls the following features:

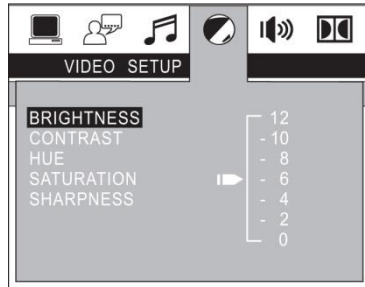

- Brightness: Adjust the brightness of the screen from the following levels: 12, 10, 8, 6, 4, 2 or 0.
- Contrast: Adjust the contrast of the screen from the following levels: 12, 10, 8, 6, 4, 2 or 0.
- Hue: Adjust the hue of the screen from the following levels: +6, +4, +2, 0, -2, -4 or -6.
- Saturation: Adjust the saturation of the screen from the following levels: 12, 10, 8, 6, 4, 2 or 0.
- Sharpness: Adjust the sharpness of the screen from the following levels: 8, 6, 4, 2 or 0.

Speaker Setup

The Speaker Setup menu controls the following features:

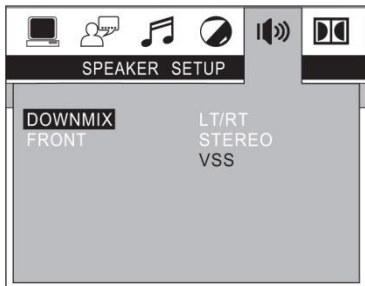

- Downmix: Choose LT/RT, STEREO or VSS.
- Front: Choose LARGE or SMALL.

Digital Setup

The Digital Setup menu controls the following features:

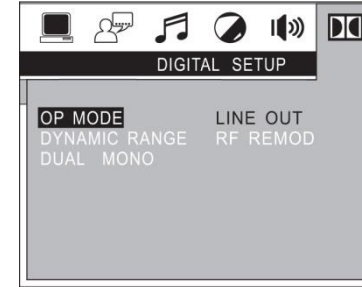

- OP Mode: Select LINE OUT or RF REMOD.
- Dynamic Range: Select FULL, 6/8, 4/8, 2/8 or OFF.
- Dual Mono: Select STEREO, MONO/L, MONO/R or MIX MONO.



DESIGNED TO MOVE [you]

CARE AND MAINTENANCE

- Keep the product dry. If it does get wet, wipe it dry immediately. Liquids might contain minerals that can corrode the electronic circuits.
- Keep the product away from dust and dirt, which can cause premature wear of parts.
- Handle the product gently and carefully. Dropping it can damage circuit boards and cases, and can cause the product to work improperly.
- Wipe the product with a dampened cloth occasionally to keep it looking new. Do not use harsh chemicals, cleaning solvents, or strong detergents to clean the product.
- Use and store the product only in normal temperature environments. High temperature can shorten the life of electronic devices, damage batteries, and distort or melt plastic parts.

Ignition

The most common source of noise in reception is the ignition system. This is a result of the radio being placed close to the ignition system (engine). This type of noise can be easily detected because it will vary in intensity of pitch with the speed of the engine.

Usually, the ignition noise can be suppressed considerably by using a radio suppression type high voltage ignition wire and suppressor resistor in the ignition system. (Most vessels employ this wire and resistor but it may be necessary to check them for correct operation.) Another method of suppression is the use of additional noise suppressors. These can be obtained from most CB/A radio or electronic supply shops.

Interference

Radio reception in a moving environment is very different from reception in a stationary environment (home). It is very important to understand the difference.

AM reception will deteriorate when passing under a bridge or when passing under high voltage lines. Although AM is subject to environmental noise, it has the ability to receive at great distance. This is because broadcasting signals follow the curvature of the earth and are reflected back by the upper atmosphere.

TROUBLESHOOTING

Symptom	Solution
Radio will not turn ON or No front panel operation	Try the reset button.
	Check fuse.
	Check 12V+ on accessory wire to radio (RED wire).
	Check Ground.
Radio turns ON, but no sound	Verify Volume, Fader/Balance, Mute controls are set correctly (see owner's manual).
	Try the reset button.
	Verify proper speaker selection.
	Verify proper speaker connections.
	Check for shorts or open circuits on speaker wires. • If short on "A" channel, "B & C" channels will continue to function. • If short on "B and/or C" channels, "A" channel will continue to function.
CD/DVD does not load fully	Make sure unit has power and no other CD/DVD is currently inside.
	Make sure transport screw has been removed from rear of unit. Disc will load for several seconds and then eject if transport screw has not been removed.
CD/DVD does not play correctly	Check to make sure disc is inserted correctly.
	Verify disc is free from dirt, scratches, etc.
	Check with factory CDs.
	Inspect radio's chassis to verify shipping screw(s) have been removed. Check factory original CDs for compatibility warnings (due to various copy-protection, multimedia content, etc.).
No AM or FM reception	Verify you are tuned to a valid station.
	Check your antenna connection on rear of stereo.
	Try a different antenna
DVD plays sound but no video	Make sure the HDMI cable is routed from the HDMI output to the input on the television.
Unit does not respond to Remote Control	Verify that you have a clear line of sight for the IR signal.
	Check the batteries.
	Confirm the remote IR sensor is plugged into IR input (if applicable).



SPECIFICATIONS

FM Tuner

Frequency Coverage (USA)	87.5 to 107.9 MHz
Frequency Coverage (Europe)	87.5 to 108 MHz
Sensitivity	<4 μV
Stereo Separation@1 kHz	>25 dB

AM Tuner

Frequency Range (USA)	530-1710 kHz
Frequency Range (Europe)	522-1620 kHz
Sensitivity (S/N=20dB)	<63 μV

Amplifier

Output Power	6W x 8
Output Impedance	Compatible with 4-8 Ω ohms speakers, 4 ohm load minimum

DVD

Frequency Response	20-20,000 Hz
Channel Separation	50 dB
S/N Ratio	65 dB
Distortion	0.5%

General

Power Supply Requirements	DC 12 Volts, Negative Ground
Operating Voltage	11-16 VDC
Overall Dimensions	265.0mm (W) x 178.0mm (D) x 158.8mm (H) 10.4" (W) x 7. 0" (D) x 6.25" (H)
Mounting Dimensions	236.2mm (W) x 155.2mm (D) x 73.6mm (H) .9.3" (W) x 6.11" (D) x 5.12" (H)
Weight	1.86 KG .4.10 lbs

FCC Notes

WARNING! Changes or modifications to this unit not expressly approved by the party responsible for compliance could void the user's authority to operate the equipment.

NOTE: This equipment has been tested and found to comply with the limits for a Class B digital device, pursuant to Part 15 of the FCC Rules. These limits are designed to provide reasonable protection against harmful interference in a residential installation.

This equipment generates, uses and can radiate radio frequency energy and, if not installed and used in accordance with the instructions, may cause harmful interference to radio communications.

However, there is no guarantee that interference will not occur in a particular installation. If this equipment does cause harmful interference to radio or television reception, which can be determined by turning the equipment off and on, the user is encouraged to try to correct the interference by one or more of the following measures:

- Reorient or relocate the receiving antenna.
- Increase the separation between the equipment and receiver.
- Connect the equipment into an outlet on a circuit different from that to which the receiver is connected.
- Consult the dealer or an experienced radio/TV technician for help.



ASA Electronics Corporation

www.asaelectronics.com

www.jensenrvdirect.com

©2015 ASA Electronics Corporation